

# Reflexlichtschranke Reflective Interrupter

## SFH 9202

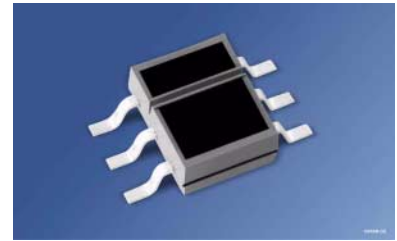

### Wesentliche Merkmale

- Optimaler Arbeitsabstand 1 mm bis 5 mm
- IR-GaAs-Lumineszenzdiode in Kombination mit einem Si-NPN-Fototransistor
- Tageslichtsperrfilter
- Geringe Sättigungsspannung
- Sender und Empfänger galvanisch getrennt
- Lötmethode: IR-Reflow Löten
- Vorbehandlung nach JEDEC Level 4

### Anwendungen

- Positionsmelder
- Endabschalter
- Drehzahlüberwachung
- Bewegungssensor

### Features

- Optimal operating distance 1 mm to 5 mm
- IR-GaAs-emitter in combination with a Silicon NPN phototransistor
- Daylight cut-off filter
- Low saturation voltage
- Emitter and detector electrically isolated
- Soldering Methode: IR Reflow Soldering
- Preconditioning acc. to JEDEC Level 4

### Applications

- Position reporting
- End position switch
- Speed monitoring
- Motion transmitter

Typ Type	Bestellnummer Ordering Code	$I_{CE}$ [mA] ( $I_F = 10$ mA, $V_{CE} = 5$ V, $d = 1$ mm)
SFH 9202	Q62702P5039	0.063 ... 0.8
SFH 9202-2/3	Q62702P5009	0.063 ... 0.2
SFH 9202-3/4	Q62702P5010	0.10 ... 0.32
SFH 9202-4/5	Q62702P5472	0.16 ... 0.50
SFH 9202-5/6	Q62702P5435	0.25 ... 0.80

**Grenzwerte**  
**Maximum Ratings**

Bezeichnung Parameter	Symbol Symbol	Wert Value	Einheit Unit
--------------------------	------------------	---------------	-----------------

**Sender (GaAs-Diode)**
**Emitter (GaAs diode)**

Sperrspannung Reverse voltage	$V_R$	5	V
Vorwärtsgleichstrom Forward current	$I_F$	50	mA
Verlustleistung Power dissipation	$P_{tot}$	80	mW

**Empfänger (Si-Fototransistor)**
**Detector (silicon phototransistor)**

Dauer-Kollektor-Emitter-Sperrspannung Continuous collector-emitter voltage	$V_{CE}$	16	V
Kollektor-Emitter-Sperrspannung, ( $t \leq 1$ min) Collector-emitter voltage, ( $t \leq 1$ min)	$V_{CE}$	30	
Emitter-Kollektor-Sperrspannung Emitter-collector voltage	$V_{EC}$	7	
Kollektorstrom Collector current	$I_C$	10	mA
Verlustleistung Total power dissipation	$P_{tot}$	100	mW

**Reflexlichtschranke**
**Light Reflection Switch**

Lagertemperatur Storage temperature range	$T_{stg}$	- 40 ... + 100	°C
Umgebungstemperatur Ambient temperature range	$T_A$	- 40 ... + 100	
Verlustleistung Power dissipation	$P_{tot}$	150	mW
Elektrostatische Entladung Electrostatic discharge	ESD	2	KV
Umweltbedingungen / Environment conditions	3 K3 acc. to EN 60721-3-3 (IEC 721-3-3)		

Kennwerte ( $T_A = 25\text{ °C}$ )

## Characteristics

Bezeichnung Parameter	Symbol Symbol	Wert Value	Einheit Unit
--------------------------	------------------	---------------	-----------------

Sender (GaAs-Diode)

Emitter (GaAs diode)

Durchlaßspannung Forward voltage $I_F = 50\text{ mA}$	$V_F$	1.25 ( $\leq 1.65$ )	V
Sperrstrom Reverse current $V_R = 5\text{ V}$	$I_R$	0.01 ( $\leq 1$ )	$\mu\text{A}$
Kapazität Capacitance $V_R = 0\text{ V}, f = 1\text{ MHz}$	$C_O$	25	pF
Wärmewiderstand <sup>1)</sup> Thermal resistance <sup>1)</sup>	$R_{thJA}$	270	K/W

Empfänger (Si-Fototransistor)

Detector (silicon phototransistor)

Kapazität Capacitance $V_{CE} = 5\text{ V}, f = 1\text{ MHz}$	$C_{CE}$	5	pF
Kollektor-Emitter-Reststrom Collector-emitter leakage current $V_{CE} = 20\text{ V}$	$I_{CEO}$	1 ( $\leq 50$ )	nA
Fotostrom (Fremdlichtempfindlichkeit) Photocurrent (outside light density) $V_{CE} = 5\text{ V}, E_v = 1000\text{ Lx}$	$I_P$	1	mA
Wärmewiderstand <sup>1)</sup> Thermal resistance <sup>1)</sup>	$R_{thJA}$	270	K/W

Kennwerte ( $T_A = 25\text{ °C}$ )

Characteristics (cont'd)

Bezeichnung Parameter	Symbol Symbol	Wert Value	Einheit Unit
--------------------------	------------------	---------------	-----------------

### Reflexlichtschranke Light Reflection Switch

Kollektor-Emitterstrom Collector-emitter current Kodak neutral white test card, 90% Reflexion $I_F = 10\text{ mA}$ ; $V_{CE} = 5\text{ V}$ ; $d = 1\text{ mm}$	$I_{CE\text{ min.}}$ $I_{CE\text{ max}}$	63 800	$\mu\text{A}$ $\mu\text{A}$
Kollektor-Emitter-Sättigungsspannung Collector-emitter saturation voltage Kodak neutral white test card, 90% Reflexion $I_F = 10\text{ mA}$ ; $d = 1\text{ mm}$ ; $I_C = 20\text{ }\mu\text{A}$	$V_{CE\text{ sat}}$	0.15 ( $\leq 0.6$ )	V

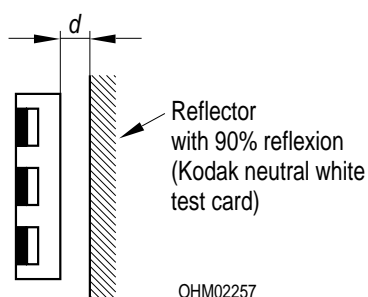
1) Montage auf PC-Board mit  $> 5\text{ mm}^2$  Padgröße1) Mounting on pcb with  $> 5\text{ mm}^2$  pad size

**Schaltzeiten** ( $T_A = 25\text{ °C}$ ,  $V_{CC} = 5\text{ V}$ ,  $I_C = 100\text{ }\mu\text{A}^1$ ,  $R_L = 1\text{ k}\Omega$ )  
**Switching Times**

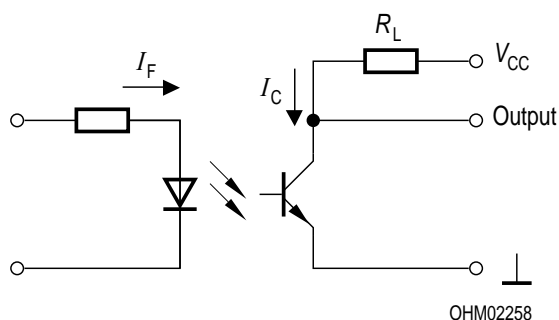

Bezeichnung Parameter	Symbol Symbol	Wert Value	Einheit Unit
Einschaltzeit Turn-on time	$t_{\text{ein}}$ $t_{\text{on}}$	40	$\mu\text{s}$
Anstiegszeit Rise time	$t_r$	30	$\mu\text{s}$
Ausschaltzeit Turn-off time	$t_{\text{aus}}$ $t_{\text{off}}$	45	$\mu\text{s}$
Abfallzeit Fall time	$t_f$	40	$\mu\text{s}$

<sup>1)</sup>  $I_C$  eingestellt über den Durchlaßstrom der Sendediode, den Reflexionsgrad und den Abstand des Reflektors vom Bauteil ( $d$ )

<sup>1)</sup>  $I_C$  as a function of the forward current of the emitting diode, the degree of reflection and the distance between reflector and component ( $d$ )

**Collector Current**  $\frac{I_C}{I_{Cmax}} = f(d)$

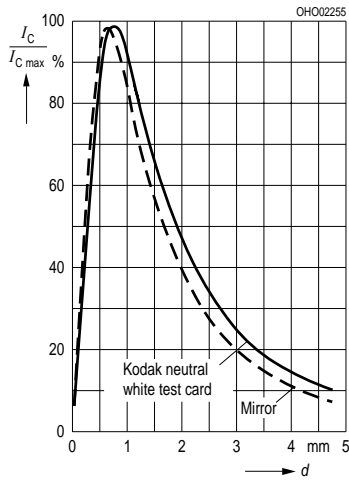

**Permissible Power Dissipation for Diode and Transistor**  $P_{tot} = f(T_A)$

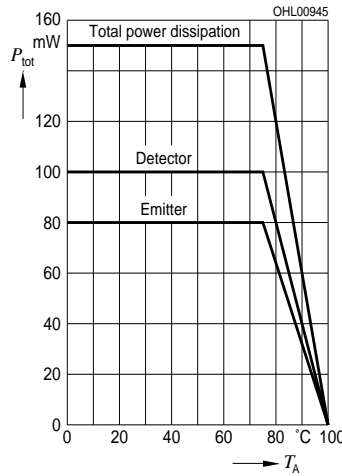

**Switching Characteristics**  $t = f(R_L)$   
 $T_A = 25\text{ °C}, I_F = 10\text{ mA}$

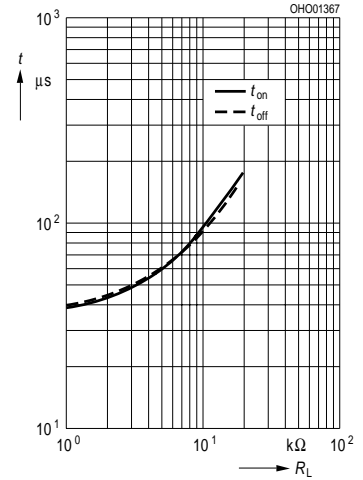

**Max. Permissible Forward Current**  
 $I_F = f(T_A)$

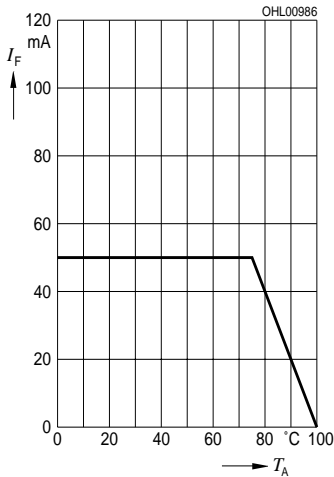

**Transistor Capacitance (typ.)**  
 $C_{CE} = f(V_{CE}), T_A = 25\text{ °C}, f = 1\text{ MHz}$

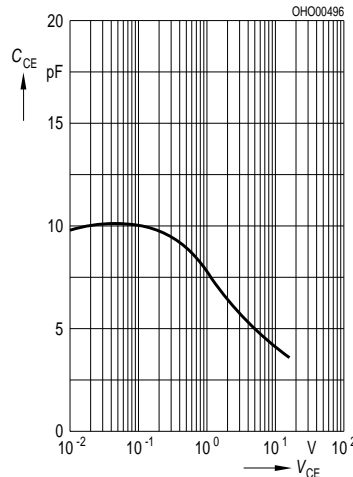

**Collector Current**  $I_C = f(I_F)$ , spacing  $d$  to reflector = 1 mm, 90% reflection

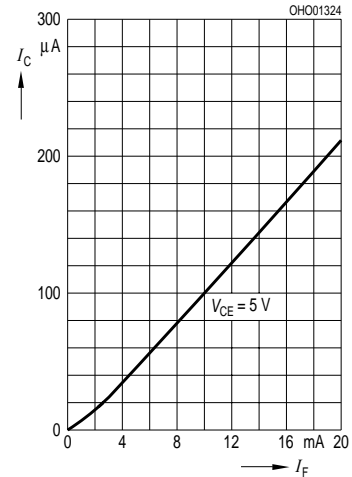

**Forward Voltage (typ.) of the Diode**  $V_F = f(T)$

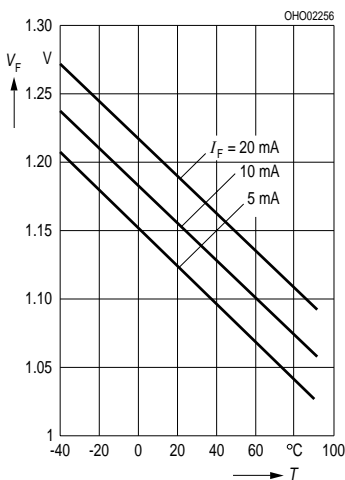

**Relative Spectral Emission of Emitter (GaAs)  $I_{rel} = f(\lambda)$  and Detector (Si)  $S_{rel} = f(\lambda)$**

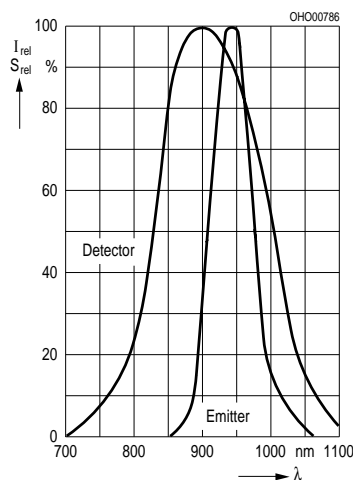

**Output Characteristics (typ.)**  
 $I_C = f(V_{CE})$ , spacing to reflector:  $d = 1\text{ mm}, 90\%$  reflection,  $T_A = 25\text{ °C}$

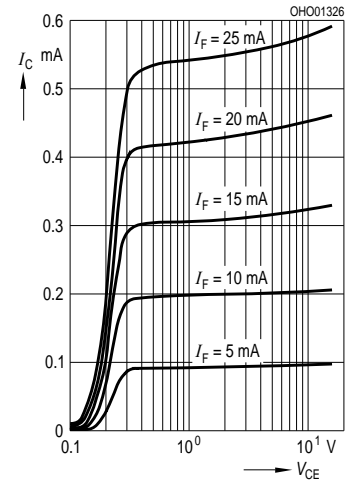

**Maßzeichnung  
Package Outlines**

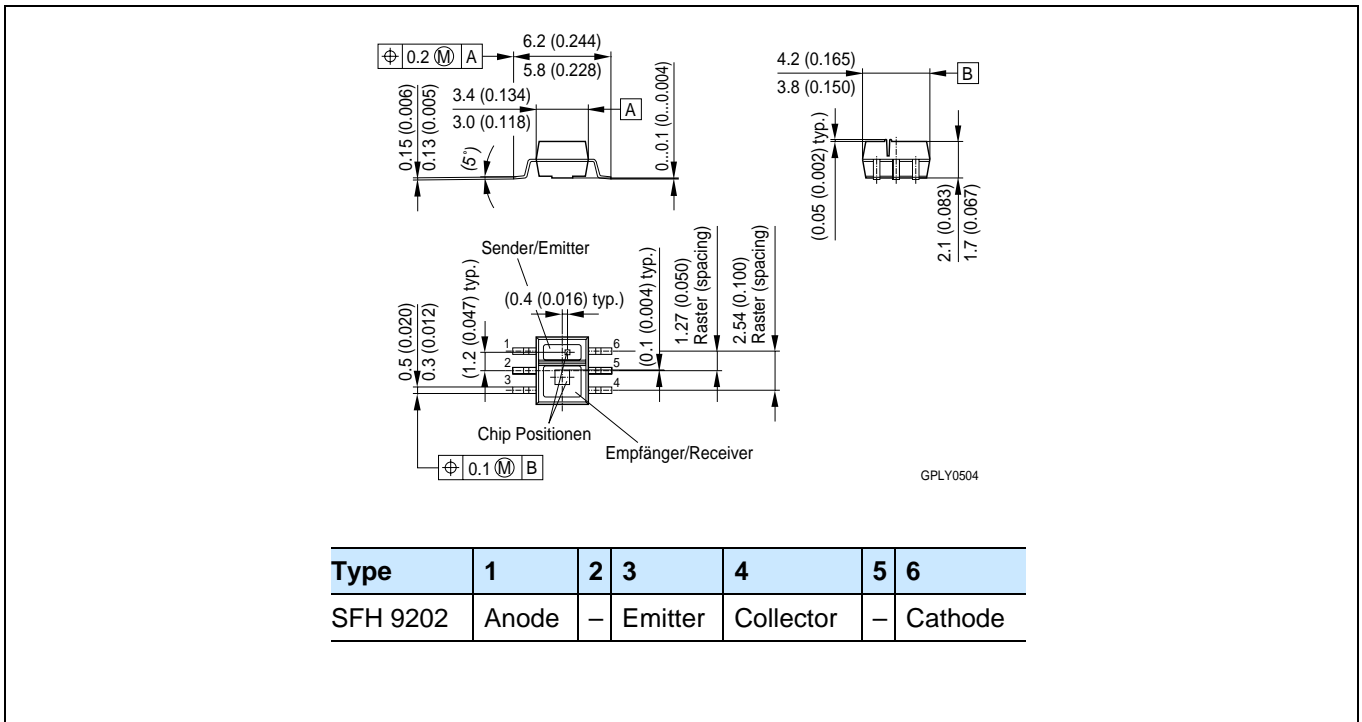

Maße werden wie folgt angegeben: mm (inch) / Dimensions are specified as follows: mm (inch).

**Empfohlenes Lötpad Design**    IR-Reflow Löten  
**Recommended Solder Pad**    IR REflow Soldering

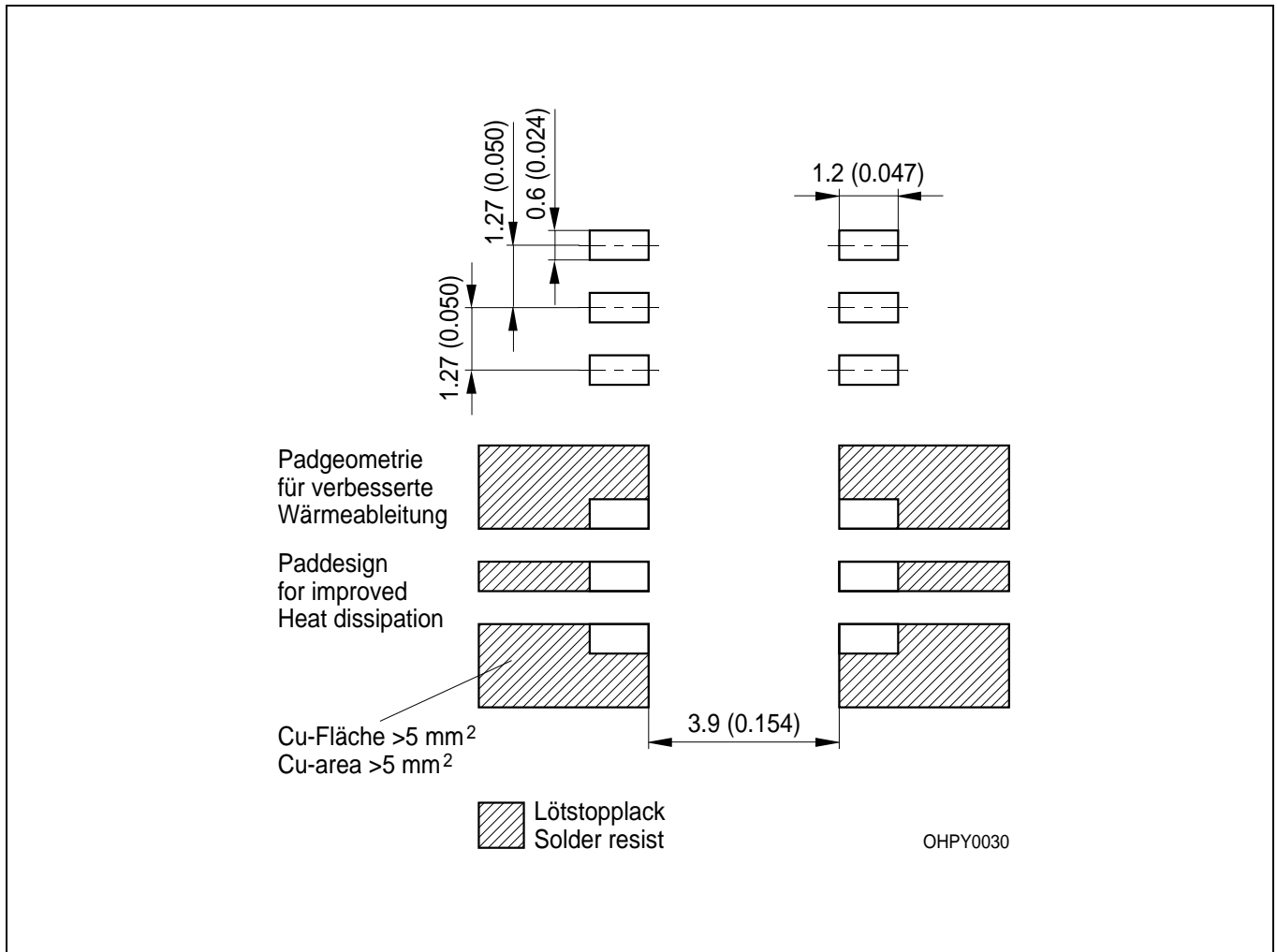

Maße werden wie folgt angegeben: mm (inch) / Dimensions are specified as follows: mm (inch).



**Löthinweise  
Soldering Conditions**

Bauform Type	Drypack Level acc. to IPS-stand. 020	Tauch-, Schwalllötung Dip, Wave Soldering		Reflowlötung Reflow Soldering		Kolbenlötung Iron Soldering (Iron temp.)
		Peak Temp. (solderbath)	Max. Time in peak zone	Peak Temp. (package temp.)	Max. Time in Peak Zone	
SFH 9202	4	n. a.	–	245 °C	10 sec.	n.a.

Bitte Verarbeitungshinweise für SMT-Bauelemente beachten!  
Please observe the handling guidelines for SMT devices!

**IR-Reflow Lötprofil** (nach IPC 9501)  
**IR Reflow Soldering Profile** (acc. to IPC 9501)

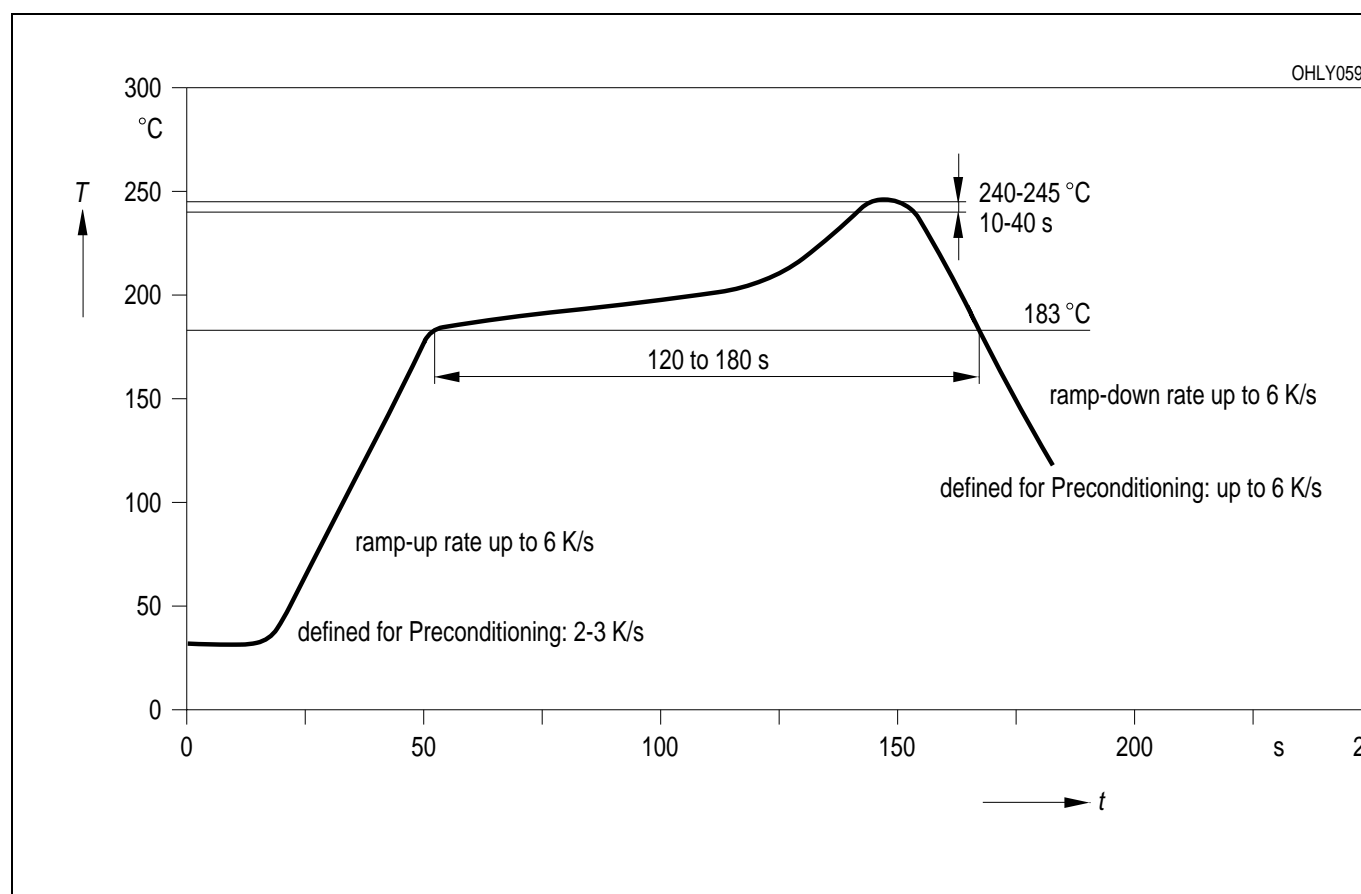

**Gurtung / Polarität und Lage**

siehe Dokument: Short Form Katalog: Gurtung und Verpackung - SMT-Bauelemente - Gehäuse:SMT RLS

**Methode of Taping / Polarity and Orientation** see document: Short Form Catalog: Tape and Reel - SMT-Components - Package: SMT-RLS

Published by  
OSRAM Opto Semiconductors GmbH  
Wernerwerkstrasse 2, D-93049 Regensburg

[www.osram-os.com](http://www.osram-os.com)

© All Rights Reserved.

The information describes the type of component and shall not be considered as assured characteristics. Terms of delivery and rights to change design reserved. Due to technical requirements components may contain dangerous substances. For information on the types in question please contact our Sales Organization.

**Packing**

Please use the recycling operators known to you. We can also help you – get in touch with your nearest sales office. By agreement we will take packing material back, if it is sorted. You must bear the costs of transport. For packing material that is returned to us unsorted or which we are not obliged to accept, we shall have to invoice you for any costs incurred.

**Components used in life-support devices or systems must be expressly authorized for such purpose!** Critical components <sup>1</sup>, may only be used in life-support devices or systems <sup>2</sup> with the express written approval of OSRAM OS.

<sup>1</sup> A critical component is a component used in a life-support device or system whose failure can reasonably be expected to cause the failure of that life-support device or system, or to affect its safety or effectiveness of that device or system.

<sup>2</sup> Life support devices or systems are intended (a) to be implanted in the human body, or (b) to support and/or maintain and sustain human life. If they fail, it is reasonable to assume that the health of the user may be endangered.